

HAKKO 471

DESOLDERING TOOL

Desoldering Tool

Instruction Manual

Thank you for purchasing the Hakko 471 Desoldering Tool.

This Manual describes the use and maintenance of the Hakko 471. Please read it before using the unit. After reading the manual, keep it in a safe place for future reference.

Table of Contents

Packing list.....	1
Precautions, Specifications, Replacement Parts.....	2
Part Names (Desoldering Gun).....	3
(Station).....	4
Operation (Preparation— Assembly and Connection).....	5
(Desoldering).....	7
(Cleaning During Operation).....	9
(Problems During Desoldering)...	10
(Troubleshooting Guide).....	11
Maintenance (Desoldering Gun).....	12
(Station).....	15
Replacing the Heating Element.....	17
Part Lists (Station).....	19
(Desoldering Gun).....	21
Wiring	22

Packing List

Please check to make sure that all the items listed below are included in the Hakko 471 package

Station.....	1	Ceramic Paper Filter (S).....	2
Desoldering Gun.....	1	Ceramic Paper Filter (L).....	4
Iron Holder Base.....	1	Spring Filter.....	3
Spring Iron Holder.....	1	Cleaning Pin (for $\phi 1.0$ mm [0.04 in] nozzle).....	1
Cleaning Sponge.....	1	Cleaning Pin/L (for Heating Element).....	1
Filter Pipe.....	1	Cleaning Pin Holder.....	1
		Instruction Manual.....	1
		Silicone Grease.....	1

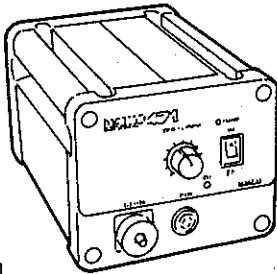

Station



Iron Holder Base

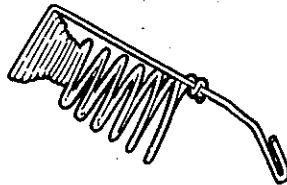

Spring Iron Holder

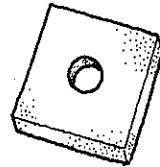

Cleaning Sponge



Filter Pipe

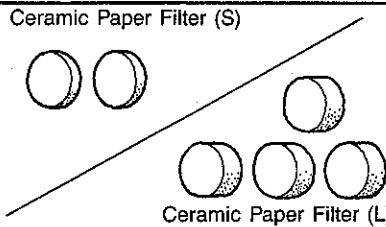

Ceramic Paper Filter (S)

Ceramic Paper Filter (L)

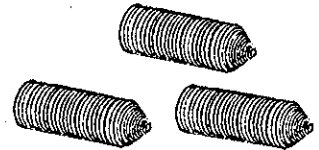

Spring Filter



Cleaning Pin for $\phi 1.0$ mm (0.04 in) Nozzle

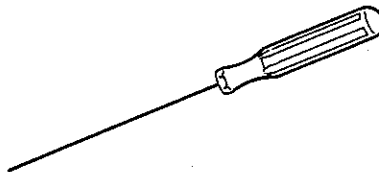

Cleaning Pin (L) for Heating Element

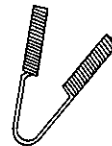

Cleaning Pin Holder

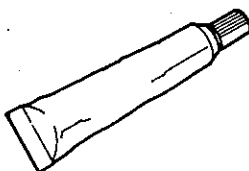

Silicone Grease

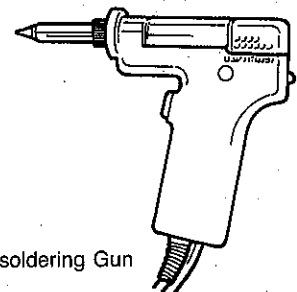

Desoldering Gun

Precautions

High Temperature

The Heating Element, Filter Pipe, other parts near these parts, and the Spring Iron Holder are all extremely hot during and immediately after operation. Be careful not to touch them at these times.

Maintenance

Please replace all expendable supplies and clean the specified parts.

Mishandling

Sharp impacts may cause parts to break or the power to drop. Handle both the Desoldering Gun and the Station with care.

Fluid

Use clean, filtered air as the fluid.

With the trigger pulled and air flowing, adjust the pressure to between 71 and 100 psi. (5.0 and 7.0 kgf/cm².)

Specifications

Name	Hakko 471					
No.	471-3	471-4	471-5	471-6	471-7	471-8
Power Source	110V	110V	220V	230V	240V	100V
Power Consumption	70W					

•Station

Part Name	Station					
Part No.	C1012	C1013	C1014	C1015	C1016	C1002
For	471-3	471-4	471-5	471-6	471-7	471-8
Output Voltage	24V AC					
Vacuum Generator	Ejector type					
Vacuum Pressure (Max)	700 mm Hg (28 in Hg)					
Flux Absorption	28ℓ/min.					
Voltage Leakage	Under 1.2mV					
Ground Resistance	Under .2Ω					
Applied Air Pressure	71 psi (5.0 kgf/cm ² .)					
Compressed Air Consumption	1.62 c.f.m. (46 ℓ/min.)					
Outer Dimensions (W×H×D)	165×135×260 mm (6.5×5.31×10.24 in)					
Weight	Approx. 3.0 kg (6.6 lb.)					

•Desoldering Gun

Part Name	Hakko 802
Part No.	C1000
Power Consumption	24V AC, 50W
Temperature	380°C ~ 480°C (716°F ~ 896°F)
Insulation Resistance	Over 300 MΩ at 420°C (790°F)
Nozzle Inside Diameter	φ1.0 (0.04 in) (Nozzle S, Standard)
Outer Dimensions (W×H)	135×174 mm (5.31×6.85 in)
Weight (w/o cord, Hose)	Approx. 200g (0.44 lb)

Condition of Measurement

•Insulation Resistance

The insulation resistance was measured between the Nozzle and the lead of the Heating Element using a 500 V DC insulation resistance meter. Caution: The insulation resistance cannot be measured between the Nozzle and the power plug as the transformer between the secondary part (Heating Element) and the primary part acts as an insulator.

•Voltage Leakage

The voltage leakage was measured between the Nozzle and the grounding Plug at a temperature of 480°C (896°F) using an AC mV meter. Caution: Be sure to ground the unit before measuring the voltage leakage.

*Specifications are subject to change without notice.

•Replacement Parts

Part No.	Part Name/Specification
A1002	Nozzle S φ0.8 mm (0.03 in)
A1003	Nozzle S φ1.0 mm (0.04 in)
A1004	Nozzle φ0.8 mm (0.03 in)
A1005	Nozzle φ1.0 mm (0.04 in)
A1006	Nozzle φ1.3 mm (0.05 in)
A1007	Nozzle φ1.6 mm (0.06 in)

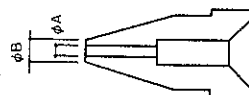
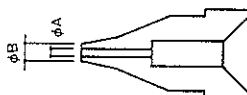

Part No.	φA	φB
A1002	0.8 (0.03 in)	1.8 (0.07 in)
A1003	1.0 (0.04 in)	2.0 (0.08 in)

Part No.	φA	φB
A1004	0.8 (0.03 in)	2.3 (0.09 in)
A1005	1.0 (0.04 in)	2.5 (0.1 in)
A1006	1.3 (0.05 in)	3.0 (0.12 in)
A1007	1.6 (0.06 in)	3.0 (0.12 in)

Part No.	Part Name/Specification
B1085	Cleaning Pin (L) for Heating Element
B1086	Cleaning Pin for φ0.8 mm (0.03 in) Nozzle
B1087	Cleaning Pin for φ1.0 mm (0.04 in) Nozzle
B1088	Cleaning Pin for φ1.3 mm (0.05 in) Nozzle
B1089	Cleaning Pin for φ1.6 mm (0.06 in) Nozzle

Part No.	Part Name/Specification
B1128	Filter Pipe w/Front Holder & Filters
A1009	Ceramic Paper Filter (S) 10 pcs.
A1033	Ceramic Paper Filter (L) 10 pcs.
A1030	Spring Filter 10 pcs.
A1029	Heating Element 24V, 50W
A1028	Silicone Grease
609-029	Cleaning Sponge

Part Names (Refer to pp. 19, 20, 21 for part nos.)

● Desoldering Gun

Nozzle

Transmits heat for melting solder.
Entrance for melted solder.
Expendable part.

Filter Pipe

Contains melted solder and flux
using filters.
Filters are expendable parts.

Back Holder Assembly

Secures the Filter
Pipe.

Release Knob

Push down to
remove Filter
Pipe.

Heating Element

Inside requires cleaning.

Indicator

Indicates when
Nozzle and Heating
Element need
cleaning and when
Filters need
replacing.

Trigger

Squeeze to start
Absorption.

Hose

Connects to the Vacuum Outlet
Cap.

Cord Assembly

Connects to the Receptacle.

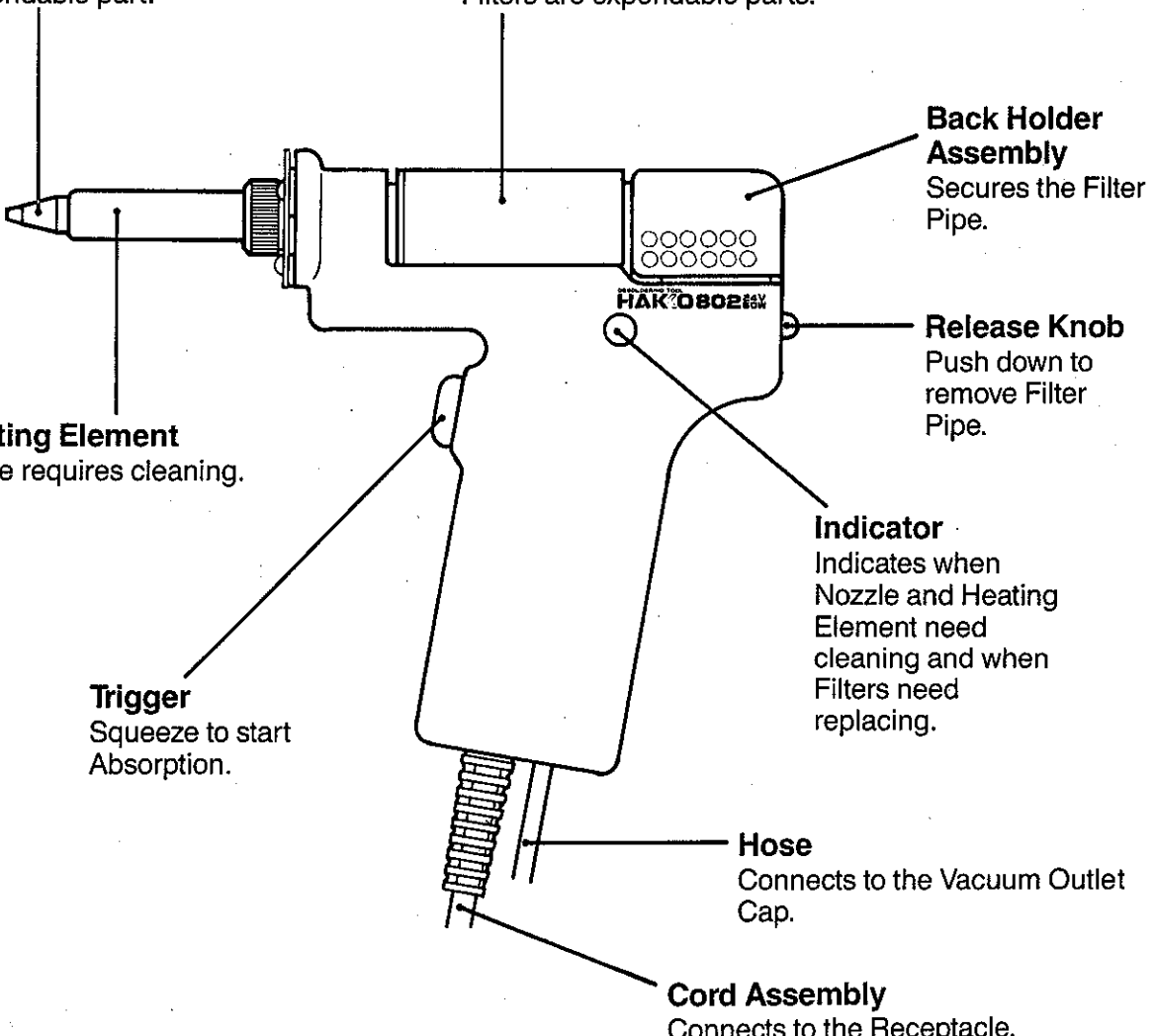

● Station

Temperature Control Knob
Provides Nozzle temperature control. (refer to p.7)

Temperature Control Knob Securing Screw
Prevents the Temperature Control Knob from being reset. (refer to p.7)

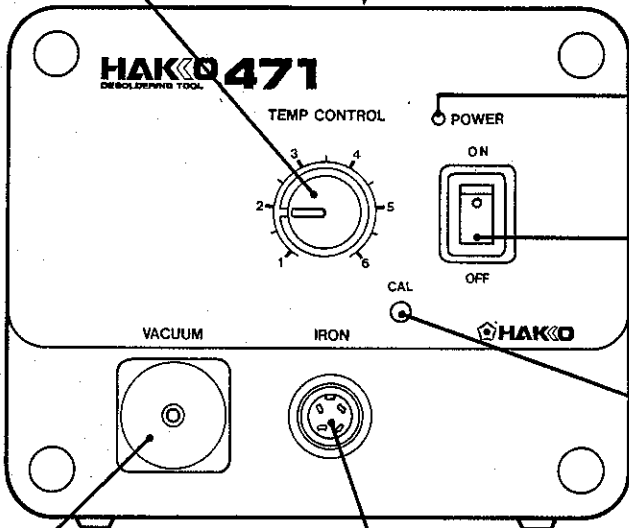

Power Lamp
Lights up when the Power Switch is turned to ON.

Power Switch
When turned to ON, the Heating Element starts to heat up.

CAL (Calibration)
Used for calibrating the temperature after replacing the Heating Element.

Vacuum Outlet Cap
Connects with the Hose. Filter inside Vacuum Outlet Cap is expendable.

Receptacle
Connector for the Cord Assembly.

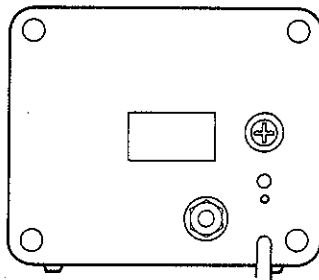

Female Connector
Supplier inlet for compressor air. Tapered screw; PT 1/8

Fuse Holder

- 100, 110, 120V Unit Contain 125-2A fuse.
- 220, 230, 240V Unit Contain 250-1A fuse.
- Australian 240V Unit Contain 250-1A Ⓢ fuse.

Power Cord

Operation

Preparation—Assembly and Connection

Assemble the Hakko 471 on a flat surface.

① Assemble the Iron Holder

- Set the Spring Iron Holder and Cleaning Pin Holder in the Iron Holder Base.
- Dampen the Cleaning Sponge with water and then squeeze it dry.

② Insert the Desoldering Gun and Cleaning Pins

- Fully insert the Desoldering Gun into the Spring Iron Holder.

Caution:

The Spring Iron Holder becomes extremely hot during operation of the Desoldering Gun. Do not touch the Spring Iron Holder during and immediately after using the Gun.

③ Connections

- Connect the Cord Assembly to the Receptacle (marked "IRON").
- Never connect or disconnect the Cord Assembly while the Power Switch is set to "ON".
- Connect the Hose to the Vacuum Outlet Cap (marked "VACUUM").

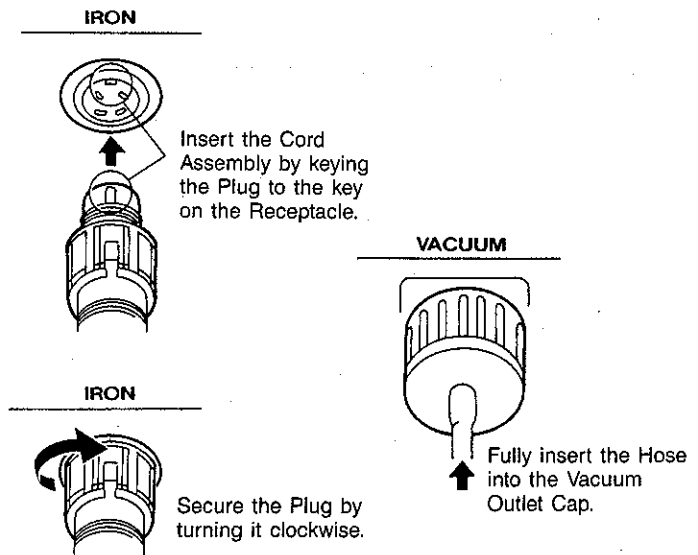
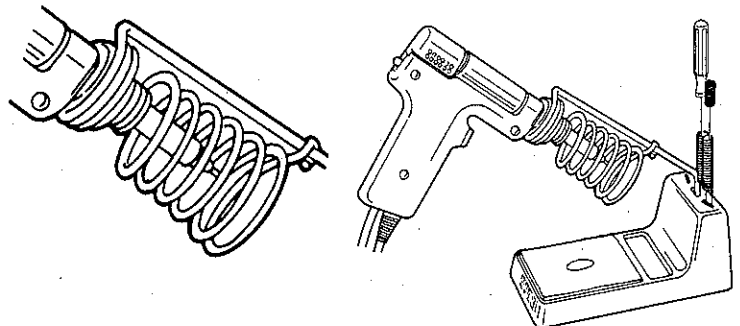
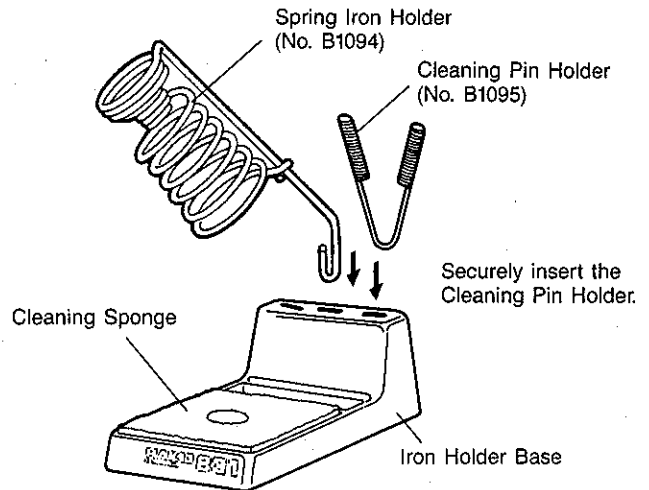

④ Connect to the Compressor

- Use filtered air to clean away any dust, oil and moisture.
- With the trigger pulled and air flowing, adjust the regulator air pressure to 71 psi to (5.0kgf/cm²).

Caution:

The absorption power of the unit will be reduced if adjustment is made while air is not flowing or if the Tube is not measured as specified. Do not set the regulator to pressures of 128 psi (9 kgf/cm²) or more while the Trigger is not pulled, as such pressures can damage various parts of the Hakko 471 Station.

⑤ Power Switch

- Confirm that the Power Switch is set in the OFF position, then connect the power plug to the power source.

Note: The entire unit is constructed of conductive materials. Always ground the unit.

- Turn the Power Switch to ON. The Power Lamp should light up.
- The Nozzle begins to heat up as soon as the Power Switch is turned to ON.

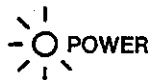
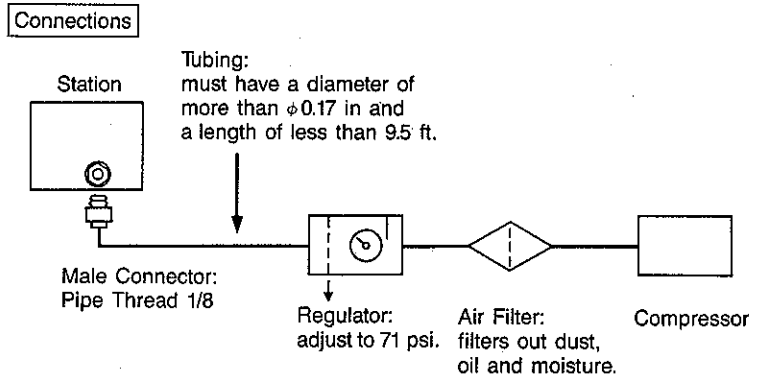

ON

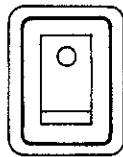

OFF

The Power Lamp lights up.



The Nozzle heats up.

The Power Lamp doesn't light up.

1. Is the Power Cord properly connected?
2. Is the fuse blown?

The Nozzle doesn't heat up.

1. Is the Cord Assembly properly connected?
2. Is the Heating Element broken?

- #### ⑥ After turning the Power Switch to ON, wait 3 minutes before beginning desoldering operations.

Operation

Desoldering

After turning the Power Switch to ON, wait 3 minutes before beginning desoldering operations.

① Set the temperature

Note: Always set the temperature to as low as possible for the work being done.

- To more precisely set the temperature, measure the temperature at the Nozzle using a soldering iron thermometer and adjust the Temperature Control Knob accordingly.
- For volume desoldering, the Temperature Control Knob can be secured by tightening the Temperature Control Knob Securing Screw ("+" screw) at the top of the 471 unit.

② Clean the tip of the Nozzle

- Keep the solder-plated section of the Nozzle a shiny white by coating it with a small amount of solder.

If the tip of the Nozzle is coated with oxide, the Nozzle's heat conductivity will be lowered. Coating the tip with a small amount of fresh solder ensures maximum heat conductivity.

The Temperature can be adjusted between 380°C (716°F) and 480°C (896°F) ($\pm 16^\circ\text{C}/\pm 30^\circ\text{F}$) with Temperature Control Knob.

This Unit has excellent thermal recovery to operate with lower temperature than conventional desoldering tool. We recommend to operate under position '2' (398°C, $\pm 16^\circ\text{C}/750^\circ\text{F} \pm 30^\circ\text{F}$)

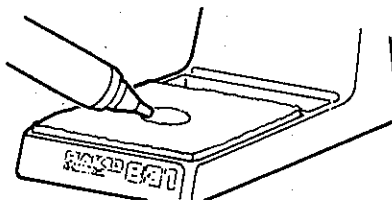
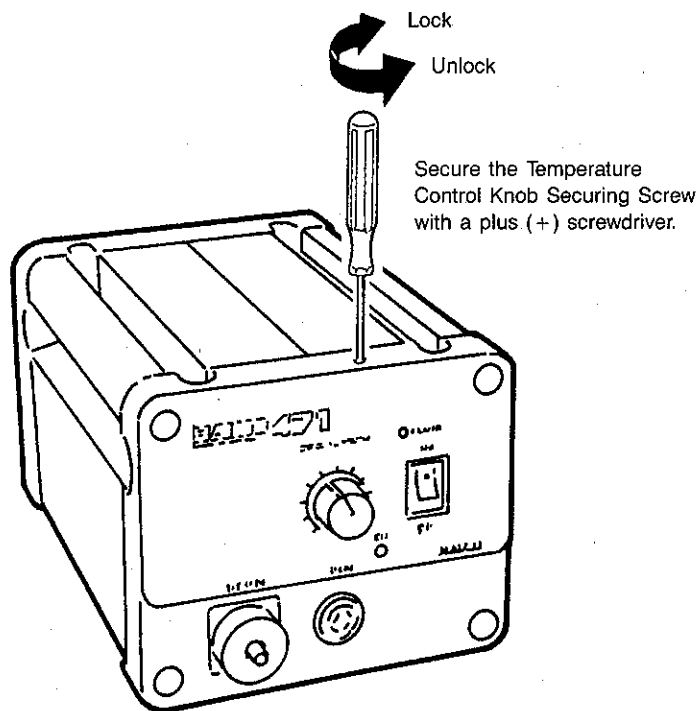

Wipe away any oxide or old solder from the Nozzle using the hole in the center of the sponge.

③ Melt the solder.

- Apply the Nozzle to the soldered part and melt the solder.

Note: Never allow the Nozzle to touch the board itself.

- Confirm that the solder is melted.

Note: To confirm that all the solder is melted, observe the inside of the hole and the backside of the PWB. If this is difficult to do, try slowly moving the lead with the Nozzle—if the lead moves, the solder is melted.

Note: Never move the lead by force. If it doesn't move easily, the solder isn't yet fully melted.

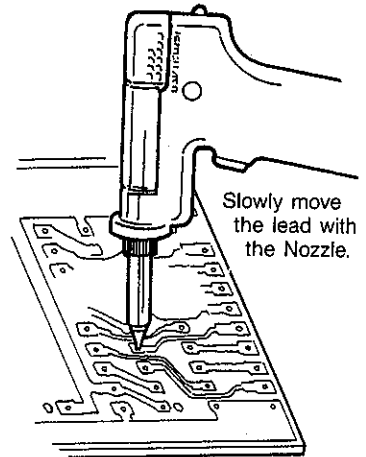
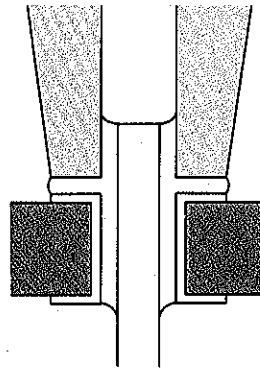
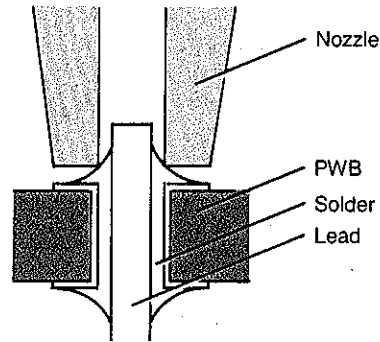

④ Absorb the solder.

- After confirming that the solder is completely melted, absorb the solder by squeezing the trigger on the Gun.

Note: Never leave any solder remaining inside the hole in the PWB.

- After fully absorbing all the solder, cool the soldering junction in order to prevent it from becoming resoldered.

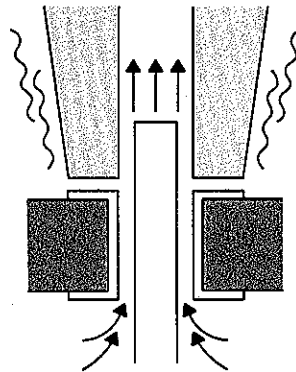

Absorb the solder by slowly moving the lead back and forth with the tip of the Nozzle.

⑤ Problems during Desoldering.

- If solder remains, resolder the component and repeat the desoldering process.

Operation

Heated solder and flux can cause oxides to form and adhere to the Nozzle and the inside of the Heating Element. These oxides not only lower the heat conductivity, but can also clog the Nozzle and Heating Element, resulting in a drop in suction efficiency. Should there be a noticeable drop in suction efficiency during operation, replace the filter and clean the Nozzle and Heating Element with the provided Cleaning Pin.

Cleaning during Operation

① Observing the Indicator



While looking at the indicator and with the hole of the Nozzle open, pull the trigger and look at the indicator. If it is red, clean the Nozzle and Heating Elements, empty the Filter Pipe, and replace the Filters. If the indicator is blue, cleaning is not necessary and operations can be resumed.

Note: The indicator will not operate accurately if the hole of the nozzle is closed or if the solder in the hole of the PWB is not melted.

Note: The indicator on Hakko 470 is read in a different way. For instructions on the reading the 470 indicator, please refer to the Hakko 470 instruction manual.

② Replacing the Filter

During operation, the Filter Pipe is very hot. Wait until the Filter Pipe is cool before replacing the Filter. We recommend keeping a second Filter Pipe containing new Filters handy, and replacing the installed Filter Pipe with this backup Filter Pipe.

Normal	Abnormal	Solution
		If three-fourths or more of the indicator is red, replace the filter and clean the Nozzle and the inside of the Heating Element. (refer to p.12, Maintenance of the Gun)
One-half or less of the indicator is red.	Three-fourths of the indicator is red.	

Replace the entire Filter Pipe with the provide backup Filter Pipe.

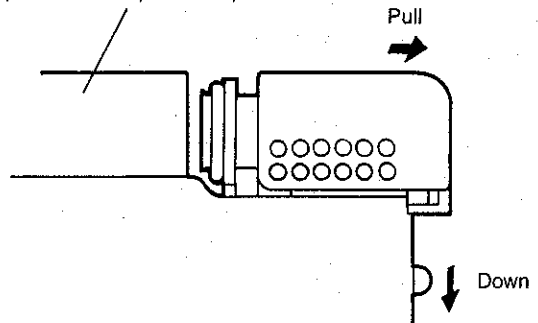

Problems during Desoldering

- A. The solder in the junction is not sufficiently melted.
- B. Suction power is dropping.

A. The solder in the junction is not sufficiently melted.

● Temperature is not high enough.

The following parts require a greater heat capacity to desolder.

- Multi-layer PWBs, power supplies, ground planes in through-hole PWBs high-capacity transistors, triacs with heat radiation fins, tuner PWB ground wires, and large-scale transformer terminals.

Use a preheating oven or heating gun to heat the PWB to a temperature that won't damage the board or its components [between 70°C (160°F) and 80°C (180°F)], then desolder. Do not increase the temperature of the gun by recalibration as this may damage the PWB board and its components.

● Nozzle is worn out.

- When the Nozzle begins to wear out, the heating efficiency begins to decline. Check the Nozzle. If the solder plating is damaged (p.12), or the Nozzle is eroded (p.12), replace the Nozzle.

B. Suction Power is dropping.

- Replace the Filters, and clean the Nozzle and the inside of the Heating Element. (refer to p.12, Gun and Station Service)

● Air is leaking from the vacuum system.

Air leakage cannot be determined from the indicator. Check the air-tightness of the following parts and replace any that are worn.

- | | |
|--|--------------------------|
| a. Contact point of the Nozzle and Heating Element | c. O-ring in Back Holder |
| b. Front Holder and nearby parts. | d. Hose |
| | e. Vacuum Outlet Cap |

Post-operation Maintenance

To ensure a long service life, always perform the following maintenance procedures immediately after using the Hakko 471 unit.

- Remove all solder from the inside of the Nozzle and Heating Element.
- Clean the tip of the Nozzle with the Cleaning Sponge, then coat the tip with a fresh layer of solder to protect the solder plating.

Troubleshooting Guide

- **Power Lamp does not light up.**
 - **Is the Power Cord plugged in correctly?**
Securely insert the Power Cord into the power supply.
 - **Is the Fuse blown?**
Replace with a new fuse (2 amp.)
- **Pump does not operate.**
 - **Is the Cord Assembly properly connected?**
Reconnect the Cord Assembly (p.6)
 - **Is the Nozzle or hole in the Heating Element clogged?**
Clean it. (p.12)
- **Solder is not being absorbed.**
 - **Is the Spring Filter full of solder?**
Replace it with a new one.
 - **Is the Ceramic Filter hardened?**
Replace it with a new one.
 - **Is there a vacuum leak?**
Check the connections and replace any worn parts.
 - **Is the compressor providing the proper air pressure?**
Check the air pressure and the inside diameter and length of the tube.
- **The Nozzle does not heat up.**
 - **Is the Desoldering Gun Cord Assembly properly connected?**
Reconnect it. (p.6)
 - **Is the Heating Element damaged?**
Replace it.

Note: When repairs are needed, please send both the Desoldering Gun and the Station to your sales agent.

Maintenance (Desoldering Gun)

Properly maintained, the Hakko 471 Desoldering Gun should provide years of good service.

Efficient desoldering depends upon the temperature, and the quality and quantity of the solder and flux. Perform the following service procedures as dictated by the conditions of the Gun's usage.

The Desoldering Gun will be extremely hot. During maintenance, please wear gloves and work carefully.

Serviceing the Desoldering Gun

① Inspect and clean the Nozzle

- Plug in the power cord, turn the Power Switch On and let the Nozzle heat up.
- Clean out the hole of the Nozzle with the Nozzle Cleaning Pin.

Note: The Cleaning Pin will not pass through the Nozzle until the solder inside the Nozzle is completely melted.

- Check the condition of the solder plating on the tip of the Nozzle.
- If it is slightly worn, recoat the tip with fresh solder to prevent oxidation.
- If it is severely worn, replace the Nozzle.
- Check the condition of the surface and inside hole of the Nozzle.
- If either is worn or eroded, or the inside diameter seems unusually wide, replace the Nozzle.

Note: The inside hole and the surface of the Nozzle is plated with a special alloy. Should this alloy become eroded by high-temperature solder, the Nozzle will not be able to maintain the proper temperature.

- If the Cleaning Pin does not pass through the hole in the Nozzle, replace the Nozzle.

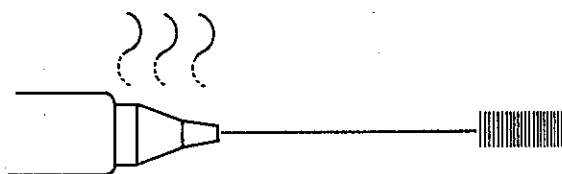

The Cleaning Pin passes completely through the hole.

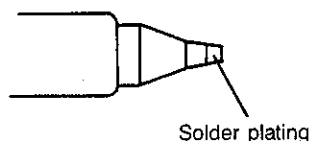

Solder plating

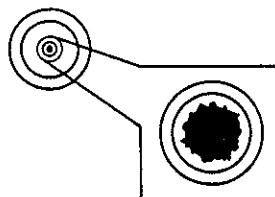

Diameter of hole is widened through erosion.

Note: Unfortunately, it is often difficult to observe this condition, therefore, if desoldering efficiency goes down and all other parts appear to be OK, the Nozzle is probably eroded and should be replaced.

② Disassemble the Heating Element

Caution: The Heating Element is very hot during operation.

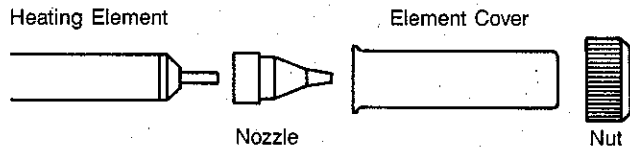

Remove the Nut.

③ Clean out the hole in the Heating Element

- Be sure the solder in the hole in the Heating Element is completely melted, then clean the hole with the provided Cleaning Pin.

Note: If the Cleaning Pin cannot pass through the hole, replace the Heating Element.

Scrape away all oxidation from the hole in the Heating Element until the Cleaning Pin passes cleanly through the hole.

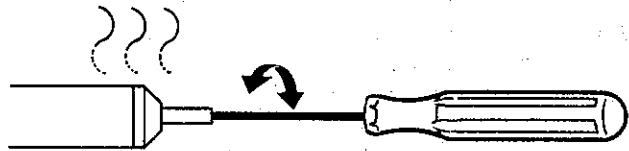

The Cleaning Pin passes cleanly and completely through the hole.

④ Replace the Filters

- Turn the Power Switch OFF.
- When the Filter Pipe is cool to the touch, push down the Release Knob at the back of the Gun and remove the Filter Pipe.

Front Holder

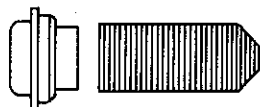

Spring Filter

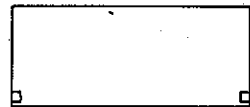

Ceramic Paper Filter
(A1033)

- Examine the Front Holder.

Replace
Stiff and cracked.

- Examine the Spring Filter.

Replace
Solder is collected in two-thirds of the Spring Filter.

- Examine the Ceramic Paper Filter. (A1033)

Replace
Ceramic Paper Filter is stiff with flux and solder.

⑤ Secure the filters

- Attach the Spring Filter to the Front Holder.
- Attach the Front Holder to the Filter Pipe.

Caution: Be sure the Front Holder is correctly aligned.

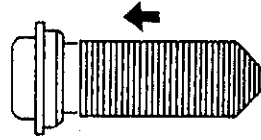

Attach the Front Holder to the Filter Pipe so that it does not leak air.

Firmly press the Back Holder Assembly into the Filter Pipe in order to properly seat the O-ring against the Pipe.

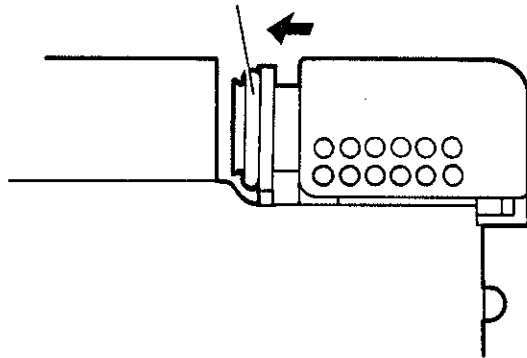

⑥ Assemble the Heating Element

- Attach the Nozzle and securely tighten the Nut.

Caution: If the nut is loose, air will leak and the temperature will drop.

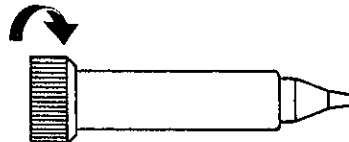

Maintenance (Station)

Cleaning the Inside of the Filter Case

① Replace the Ceramic Paper Filter (A1009)

Detach the Filter Retainer, being very careful not to let the Valve pop out. Remove the Ceramic Paper Filter and inspect it. If it is stiff with flux, replace it.

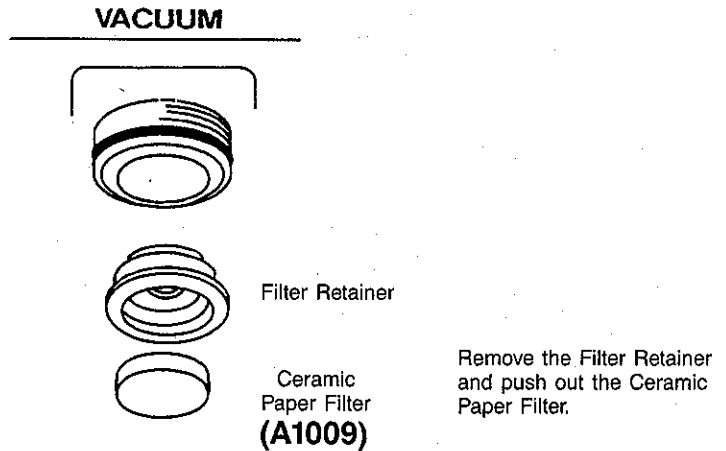

② Reassemble the Filter Case

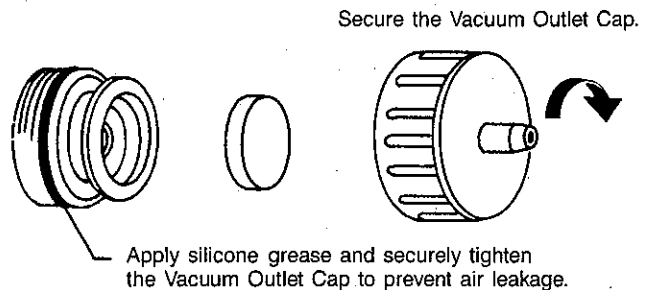

Exhaust Filter Replacement

Caution: Unplug the Power Cord before starting this procedure.

① Disassemble the Pump Heads

- Remove the Rear Panel
- Remove the Cover
- Remove the Pump Head from each side of the Pump.

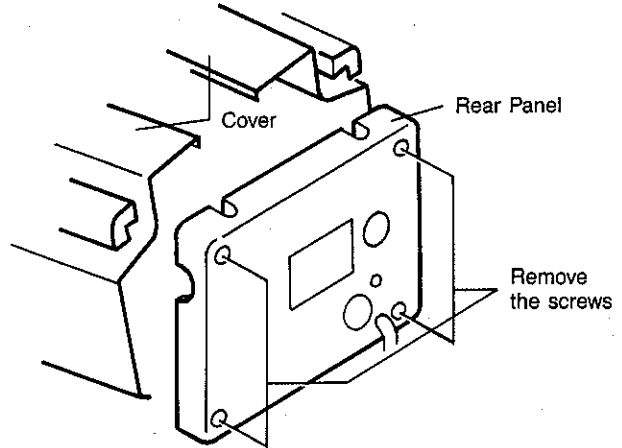

② Replacement

Check the Filter every once in a while. If it is dirty, replace it.

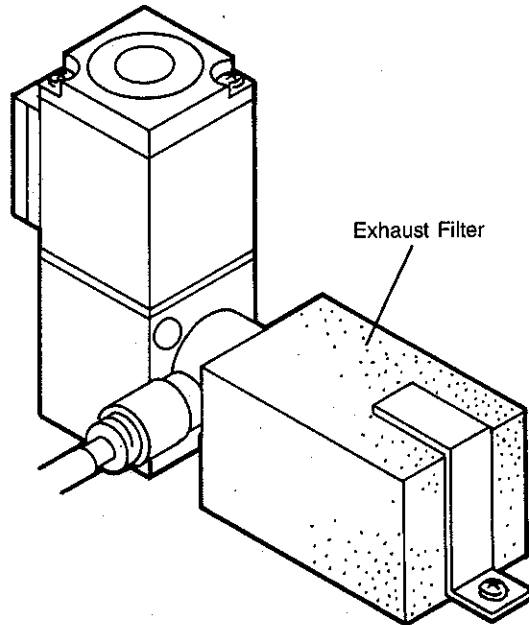

Replacement Parts

Replacing the Heating Element

The resistance value of a working Heating Element is $2-4\Omega$ at 23°C (73°F). If the value you get is outside this range, replace the Heating Element.

① Disassemble the heating parts

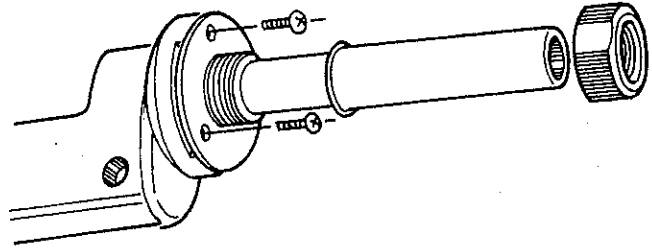

② Separate the Housing.

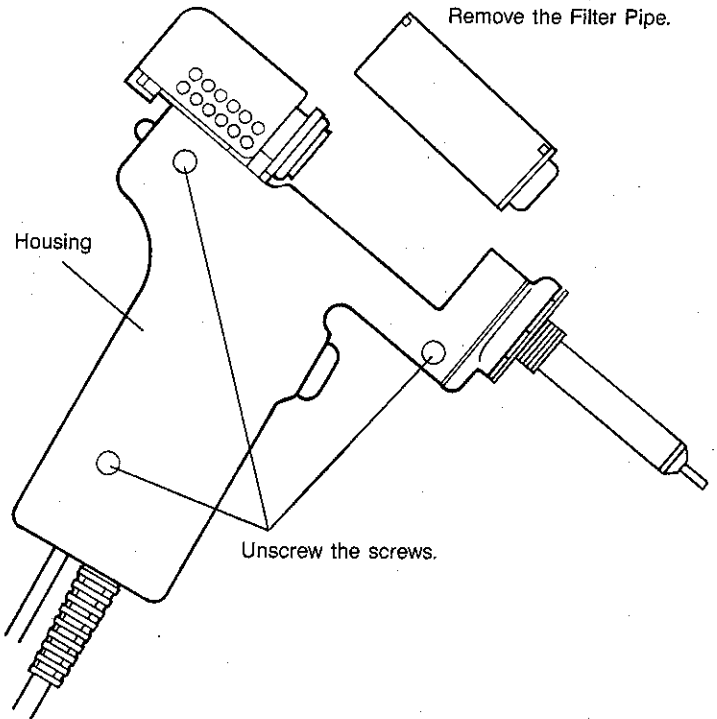

③ Detach the Terminal and remove the Heating Element.

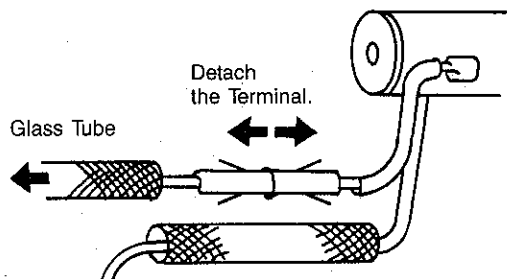

④ Insert a new Heating Element and reassemble.

Cover the Glass Tube on the connecting part.

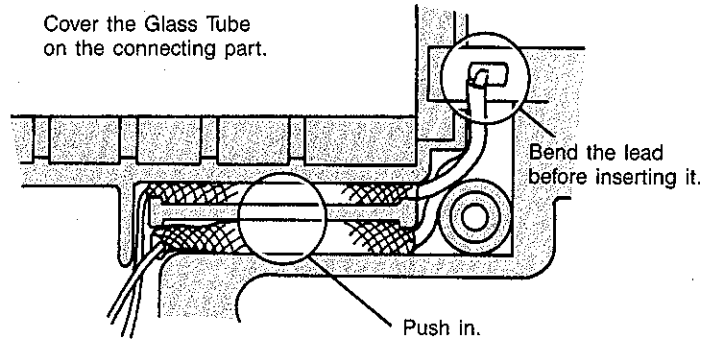

Position the leads in the groove and press them into place. Be careful that the leads do not get caught in the Housing.

⑤ Recalibrate the temperature.

The resistance of new Heating Elements varies, resulting in variations in operating temperatures. It is necessary to recalibrate the temperature every time the Heating Element is replaced.

1. Set the Temperature Control Knob to 1 and allow the Gun to warm up for 3 minutes.
2. Using a tip thermometer, adjust the temperature calibrator (marked "CAL") until the Nozzle temperature reads 380°C (716°F).

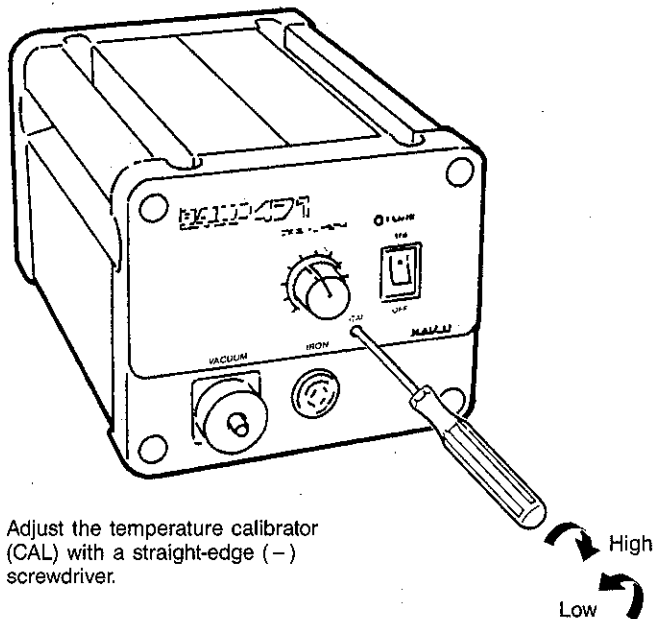

Parts List (Station)

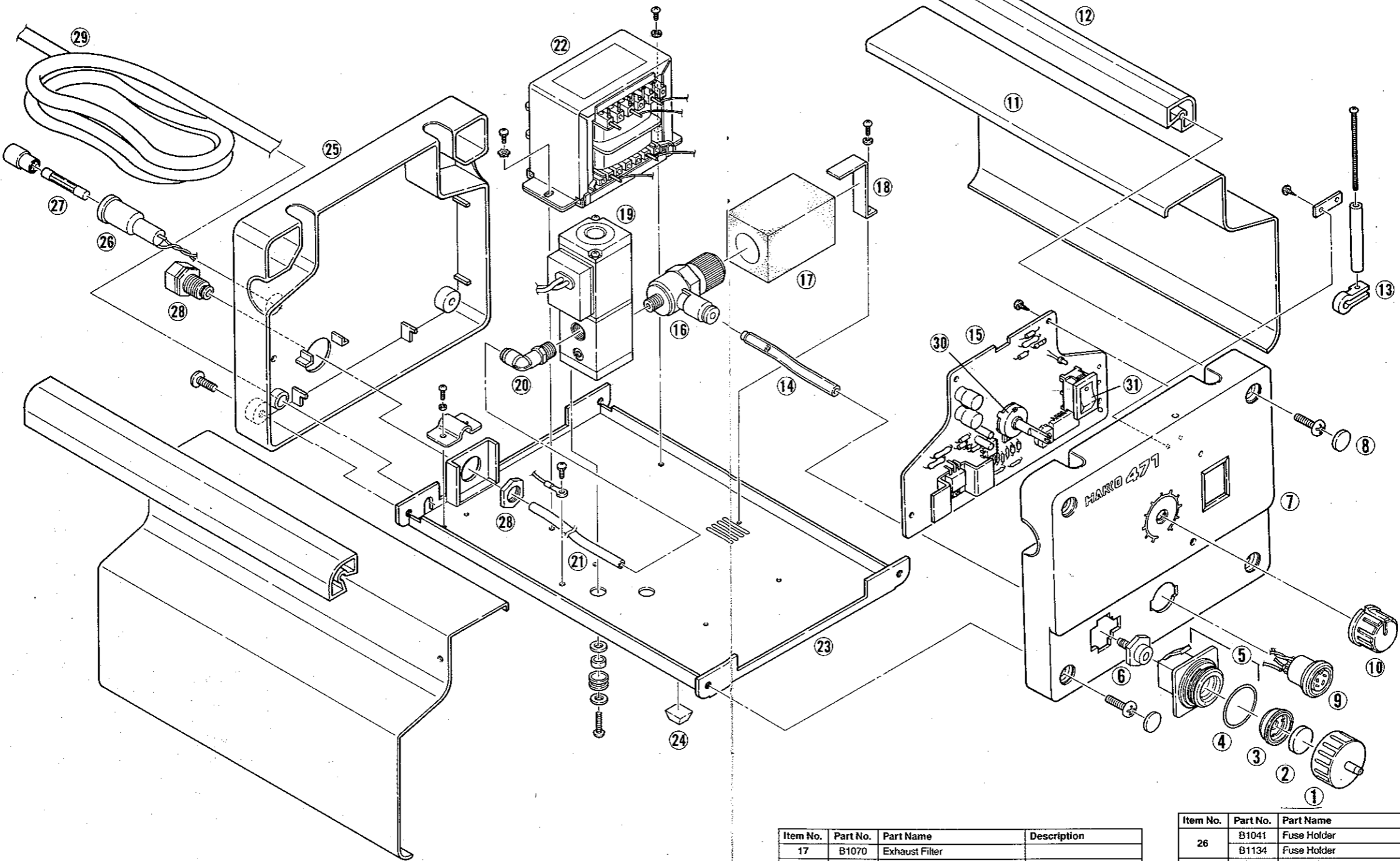

Item No.	Part No.	Part Name	Description
1	B1029	Vacuum Outlet Cap	
2	A1009	Ceramic Paper Filter (S)	10 pcs.
3	B1063	Filter Retainer	
4	B1034	O-ring (S20)	
5	B1031	Vacuum Outlet Retainer	with O-ring (S20)
6	B1064	Filter Case Joint	
7	B1062	Front Panel	
8	B1038	Cover for Securing Screw	set of 4

Item No.	Part No.	Part Name	Description
9	B1036	Receptacle	
10	B1028	Knob	
11	B1093	Cover	one side
12	B1061	Handle	one side
13	B1044	Temp. Control Set Screw Clamp	
14	B1073	Joint Hose	
15	B1068	PWB	
16	B1069	Ejector	

Item No.	Part No.	Part Name	Description
17	B1070	Exhaust Filter	
18	B1071	Exhaust Filter Retaining Clip	
19	B1074	Solenoid Valve	
20	B1075	Elbow Joint	
21	B1076	Pressure Hose	
22	B1072	Transformer	100-24V
	B1136	Transformer	110-24V
23	B1137	Transformer	220-24, 230-24, 240-24V
	B1067	Chassis	
24	B1037	Rubber Stopper	
25	B1066	Rear Panel	with Rating Seal

Item No.	Part No.	Part Name	Description
26	B1041	Fuse Holder	w/o Fuse
	B1134	Fuse Holder	w/o Fuse for Australian 240V
27	B1042	Fuse	125V-2A/100, 110V
	B1138	Fuse	250V-1A/220, 230, 240V
	B1139	Fuse	250V-1A/Australian 240V
28	B1065	Female Connector	
	B1043	Power Cord	SVT 100V
29	B1104	Power Cord	SVT 110V
	B1130	Power Cord	VCTF
	B1135	Power Cord	VSRF
30	B1078	Volume Type Temp. Control	
31	B1084	Switch	

Parts List (Desoldering Gun)

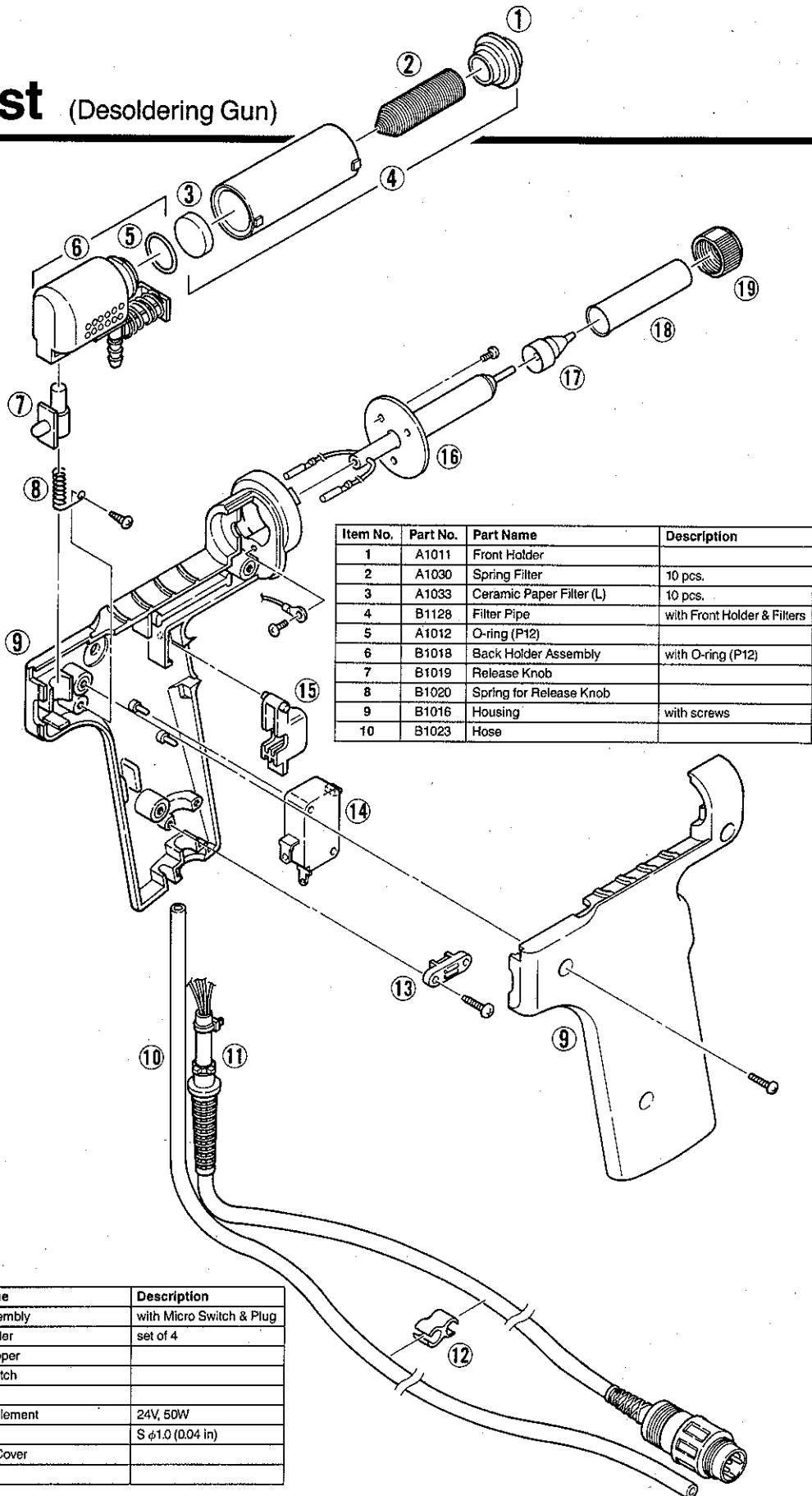

Item No.	Part No.	Part Name	Description
1	A1011	Front Holder	
2	A1030	Spring Filter	10 pcs.
3	A1033	Ceramic Paper Filter (L)	10 pcs.
4	B1128	Filter Pipe	with Front Holder & Filters
5	A1012	O-ring (P12)	
6	B1018	Back Holder Assembly	with O-ring (P12)
7	B1019	Release Knob	
8	B1020	Spring for Release Knob	
9	B1016	Housing	with screws
10	B1023	Hose	

Item No.	Part No.	Part Name	Description
11	B1025	Cord Assembly	with Micro Switch & Plug
12	B1024	Cord Holder	set of 4
13	B1022	Cord Stopper	
14	B1026	Micro Switch	
15	B1021	Trigger	
16	A1029	Heating Element	24V, 50W
17	A1003	Nozzle	S ϕ 1.0 (0.04 in)
18	B1014	Element Cover	
19	B1015	Nut	

Wiring

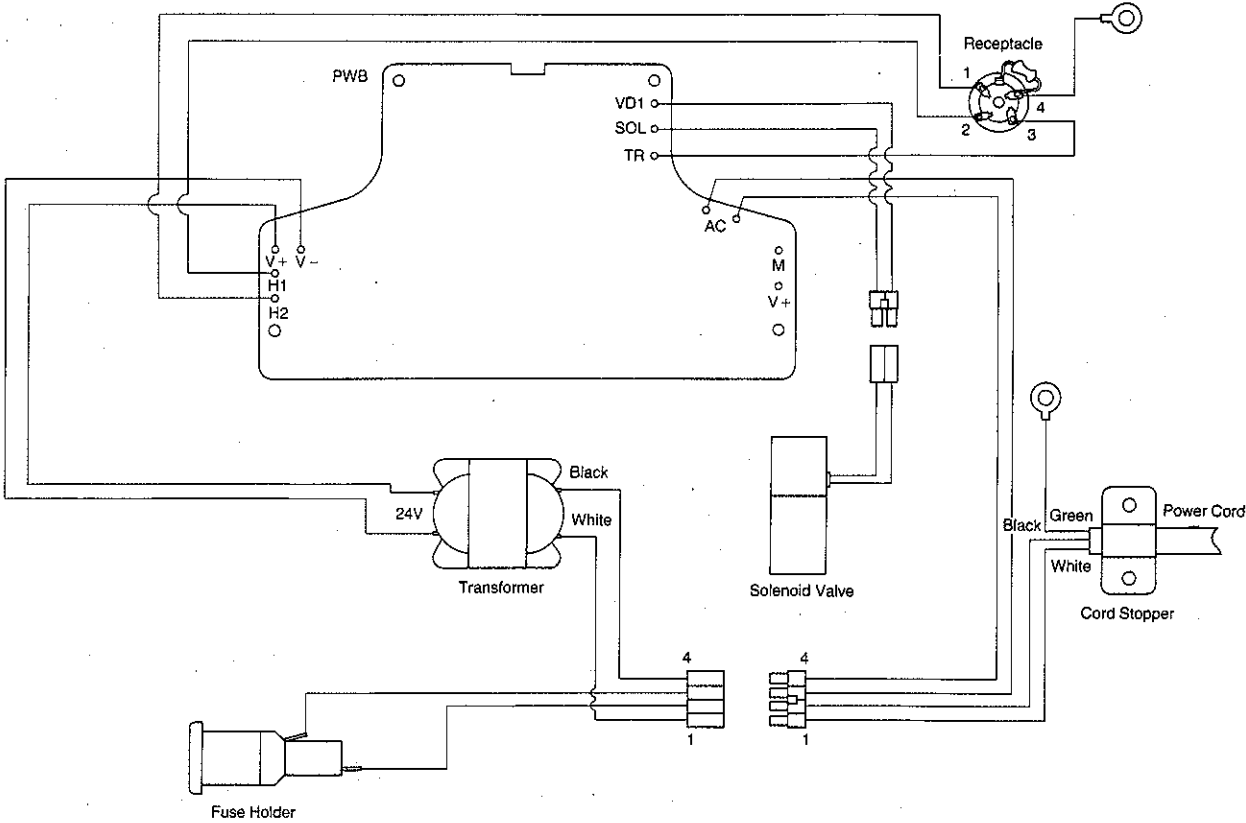



HAKKO CORPORATION

HEAD OFFICE

4-5, SHIOKUSA 2-CHOME, NANIWA-KU, OSAKA,
556 JAPAN TEL: (06) 561-3225 FAX: (06) 561-8466
TELEX: HAKKOOSA J65274

U.S. Affiliate AMERICAN HAKKO PRODUCTS, INC.

25072 ANZA DR. SANTA CLARITA, CA 91355, U.S.A.
TEL: (805) 294-0090 FAX: (805) 294-0096

EASTERN DIVISION

2634 CHAPEL HILL BLVD., STE. 325 DURHAM,
NORTH CAROLINA 27707

TEL: (919) 489-4770 FAX: (919) 489-4774

S'PORE Affiliate HAKKO PRODUCTS PTE., LTD.

1, GENTING LINK #02-04, PERFECT INDUSTRIAL
BUILDING, SINGAPORE 1334

TEL: 7482277 TLX: RS 37102 HAKKO FAX: 7440033